

WLM系列 LED多功能警示灯

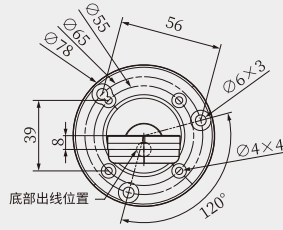

WLME-折叠式

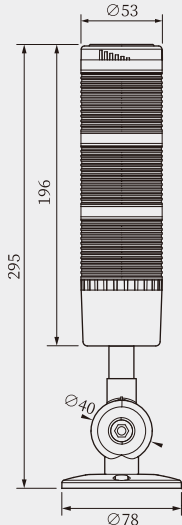

底座安装孔位

安装	螺丝位	规格	螺丝数量
形式A	Ø65	M5/M6	3
形式B	Ø55	M4	4

WLMS-直立式

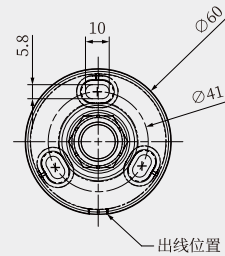
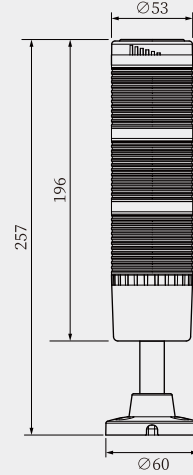

- IP20
- 24V DC
- RYG
- M12
- 0.38m
- +55 / -25
- 寿命 50000h
- 360°

产品特点

- 混合棱镜切割灯罩, 提高了远距离的可视性能
- 利用双反射镜构造用最少LED产生鲜明的彩色识别效果
- 灯体由尼龙66制成, 耐热抗冲击

- The hybrid prism cuts the lampshade to improve the long-distance visual performance
- Use of double mirror structure to produce vivid color recognition effect with minimal LED
- The lamp body is made of nylon 66, heat and shock resistance

应用场所

应用场所:

数控机床、组合机床、加工中心、安防设备、激光设备、流水线、安检系统及其他场所。

Application:

CNC machine tools, machine tool, machining center, security equipment, laser equipment, assembly line, security system and other places.

产品规格型号示例

系列	安装	层数	额定电压	类型	接线方式	信号颜色
WLM	F	3	24	F	PN	RYG
	F=折叠式 S=直立式 F=Foldable S=Straight	3=3层 3=3 Layers	24=DC24V	B=常亮 F=常亮带蜂鸣 B=Steady F=Steady with Buzzer	PN=正负通用	R=红色Red Y=黄色Yellow G=绿色Green

WLM系列LED多功能警示灯

产品参数

直径 ^① Diameter	Ø53mm	寿命 Life-span	50000小时 50000h
壳体 Housing	ABS	灯罩材质 Lampshade Material	PC
工作状态 Working Status	常亮 Steady	LED信号光源 Light Source	单色LED发光二极管 1 color of LEDs
声源 Sound Source	蜂鸣器“BBB……” Buzzer “BBB……”	光亮/音量可调 Dimmable/ Adjustable Volume	不可调 No
防护等级 Protection Degree	IP20	接线方式 Wire Connecting	共正极/共负极 Positive/Negative
额定电压 Nominal Voltage	DC 24V	延长线 Length of wire	380±15mm(标配) 380±15mm(Standard configuration)
额定电流 Rated Current	红光 0.02A 黄光 0.03A 绿光 0.01A 0.02A @Red 0.03A @Yellow 0.01A @Green		

※ 接受灯具定制, 详询我司工作人员。Customized products are welcome, please contact our staff.

①直径: 仅指灯体发光部位的直径

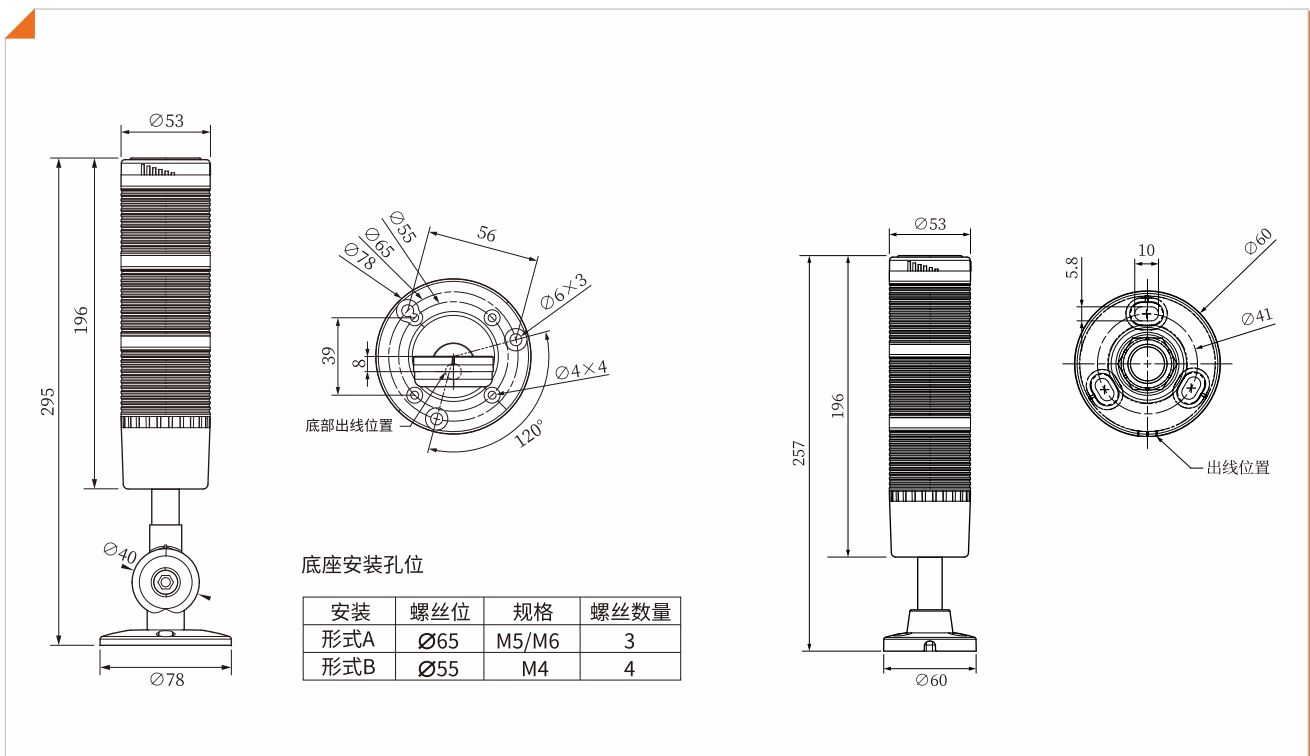

产品尺寸图

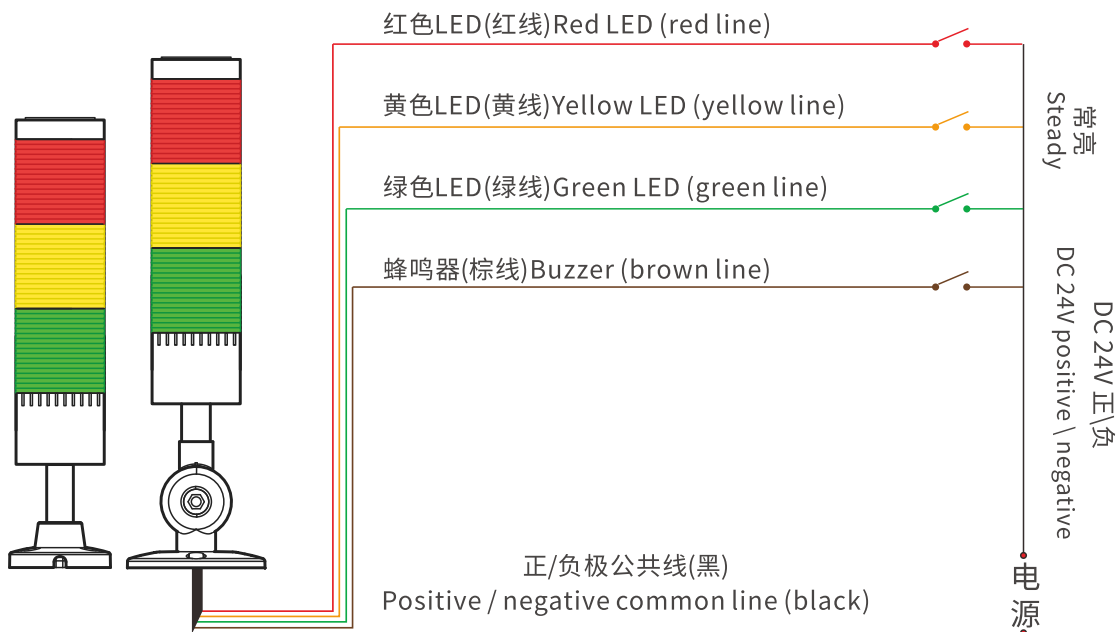

控制回路图



颜色示例

对象 Item	控制 Control	警示 Warning	状况 Status
 红色灯 Red Light	RD	危险警示 Danger warning	报警发生 Alarm
 黄色灯 Yellow Light	YL	注意警示 Pay attention to the warning	运行准备状态 Prepare for running state
 绿色灯 Green Light	GN	安全提示 Safety tips	安全运行状态 Safety operation state
连续音“BBB……” Continuant“BBB……”	BZ	—————	

WLM系列LED多功能警示灯

故障处理

现象 Phenomenon	主要原因 Main reason	处理方法 Approach
无法工作 Can not work	错误接线 Incorrect wiring	再确认接线 Reconfirm the wiring
LED部分无法发光 The LED part cannot emit light	LED部分损伤 LED damage	更换LED Replace LED
模糊的长亮 Long blurry	使用比额定电压低的电压 Use a voltage lower than the rated voltage	确认使用电压 Confirm the use voltage

⚠ 使用注意事项

- 使用电压比额定电压严重上升会缩短使用寿命或工作不良的问题发生, 要注意使用电压控制在 $\pm 5\%$ 以内。
- 灯罩或身体上接触香蕉水等化学物质, 产品表面会发生变形或变色的现象, 要特别注意。
- 不要给产品施加强烈的冲击, 会引起零部件的破损。
- 露出产品外部的电源线不能强行拉制, 会引起产品故障。
- A serious increase in the use voltage compared to the rated voltage will shorten the service life or the problem of poor working. Please pay attention to the use voltage control within $\pm 5\%$.
- When the lampshade or the body is exposed to chemicals such as banana water, the surface of the product may be deformed or discolored. Pay special attention.
- Do not apply strong impact to the product, which may cause damage to parts.
- The power cord that is exposed outside the product cannot be forcibly drawn, which may cause product failure.