

SLM21系列 六触点型安全门锁



安全防护 强制锁定

- EN 60947-5-1/IEC 60947-5-1
- GB/T 14048.5
- EN ISO 14119/ISO 14119
- GB/T 18831



SLM21系列安全门锁介绍

SLM21系列安全门锁型号丰富，操作简便，可选择操作钥匙的插入方向和可调节安装确保了安装的灵活性，锁定强度高达令人放心的1300N，IP67保护结构，保证其可以广泛应用于不同工业环境。

产品特点

- 内置有多触点结构选择
- 锁定力为1300N
- IP67防护等级
- 多种金属头部可选
- 可用一般负载或微小负载

产品参数

电磁线管		
额定工作电压	DC24V	
功率	4.8W	
额定电流	约200mA	
绝缘	B级(130°C)	
LED指示灯		
额定工作电压	DC24V	
额定电流	约1mA	
发光颜色(LED)	绿色	
安全等级	最高可达PL d 基于ISO 13849-1	
认证	CE、莱茵TUV	
标准	EN60947-5-1、IEC60947-5-1、GB/T 14048.5、EN ISO 14119、GB/T 18831	
保护等级	IP67	
材质	PA66阻燃	
机械寿命	100万次以上	
电气寿命	15万次以上(AC240V3A,电阻性负载)	
使用类型	AC-15	DC-13
额定工作电压(Ue)	240V	24V
额定工作电流(Ie)	3A	2A
电气		
接触电阻	200mΩ以下	
额定开放热电流(Ith)	10A	
额定绝缘电压(Ui)	300V	
防触电保护等级	Class II (双重绝缘)	
脉冲耐压 (EN60947-5-1)	2.5KV	
绝缘电阻	100MΩ以上	
短路保护装置	10A,250V需用速断型保险丝	
耐振动	10-55HZ双振幅1.5mm	
耐冲击	耐久1000m/s ²	
条件短路电流	100A (EN 60947-5-1)	
触点间距	2x2mm以上	
动作特性		
强制断开力	最小60N	
强制断开行程	10mm以上	
操作速度	0.1 m ~ 0.5m/s	
允许操作频率	最大30次操作/分钟	
锁定时拉拔力强度	1300N	
环境		
污染度(使用环境)	3 (EN60947-5-1)	
使用环境温度	-10°C~+55°C (无凝结)	
使用环境湿度	95%RH以下	

SLM21系列安全门锁

安全门锁型号说明(例如:SLM21-BPMF2)

产品系列	开关触点 (门开合检测开关+锁定监控开关)	头部安装方向/材质	门锁定/释放方式	释放钥匙位置	导管口尺寸
SLM21	-	□	□	□	□
<p>A: 1NC/1NO(缓动触点) + 1NC/1NO(缓动触点)</p> <p>B: 1NC/1NO(缓动触点) + 2NC(缓动触点)</p> <p>C: 2NC(缓动触点) + 1NC/1NO(缓动触点)</p> <p>D: 2NC(缓动触点) + 2NC(缓动触点)</p> <p>E: 2NC/1NO(缓动触点) + 1NC/1NO(缓动触点)</p> <p>F: 2NC/1NO(缓动触点) + 2NC(缓动触点)</p> <p>G: 2NC/1NO(缓动触点) + 2NC/1NO(缓动触点)</p> <p>H: 3NC(缓动触点) + 1NC/1NO(缓动触点)</p> <p>I: 3NC(缓动触点) + 2NC(缓动触点)</p> <p>J: 3NC(缓动触点) + 3NC(缓动触点)</p> <p>K: 3NC(缓动触点) + 2NC/1NO(缓动触点)</p> <p>L: 2NC/1NO(缓动触点) + 3NC(缓动触点)</p>		<p>P: 四个安装方向可选 (交货时为前侧安装) /塑料</p> <p>M: 四个安装方向可选 (交货时为前侧安装) /金属</p>		<p>M: 机械锁定/DC24V电磁释放</p> <p>E: DC24V电磁锁定/机械释放</p>	
				<p>T: 顶部</p> <p>F: 前面</p>	
				<p>2: M20</p>	

产品尺寸图

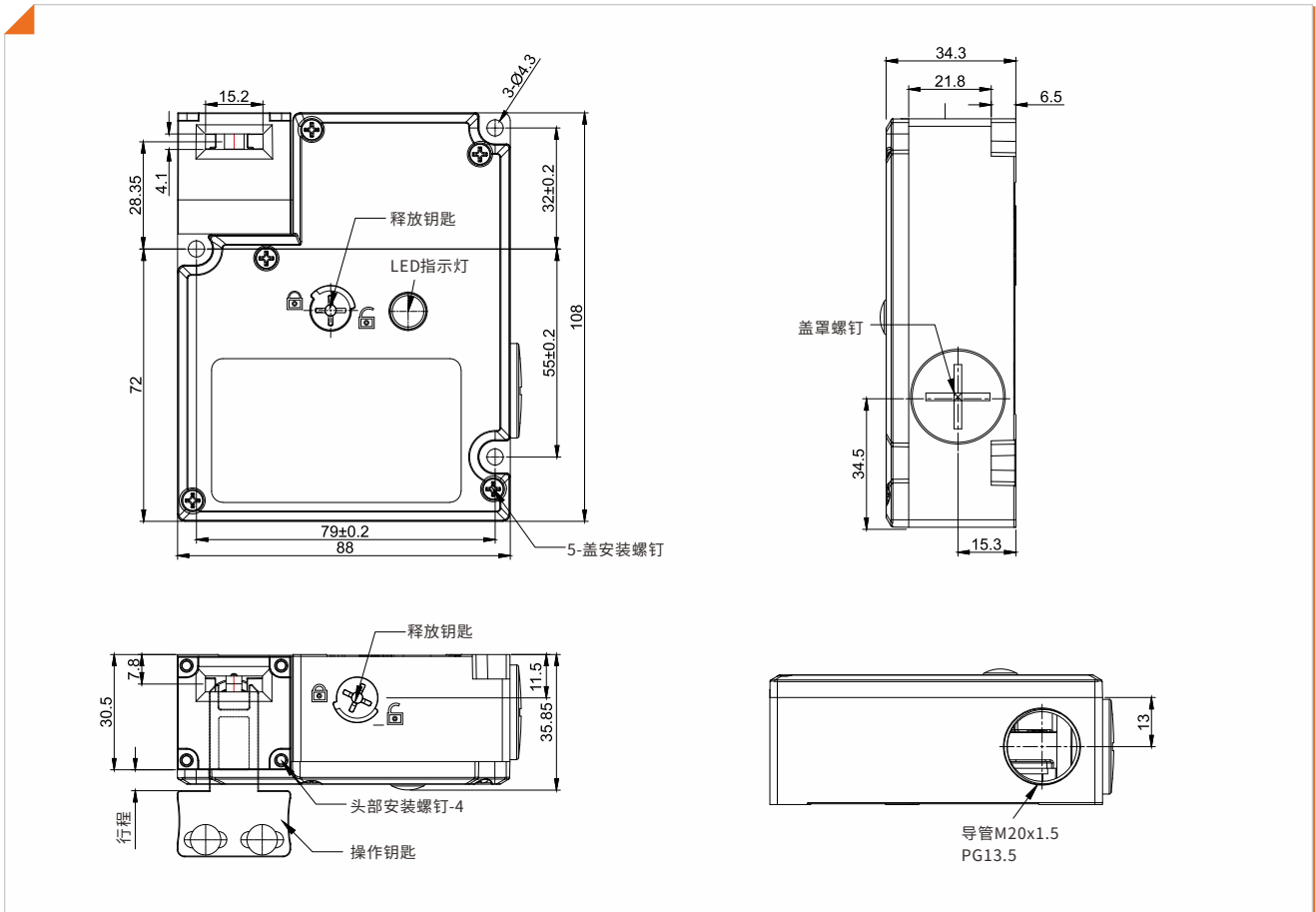

SLM21系列选型表

释放钥匙位置	头部材质	电磁铁电压/指示灯	锁定/释放方式	触点类型 (门监控+ 锁定监控)	导管口尺寸	型号
顶部解锁	塑料	电磁铁 DC24V 绿色LED	机械锁定 电磁释放	1NC/1NO + 1NC/1NO	M20	SLM21-APMT2
				1NC/1NO + 2NC	M20	SLM21-BPMT2
				2NC + 1NC/1NO	M20	SLM21-CPMT2
				2NC + 2NC	M20	SLM21-DPMT2
				2NC/1NO + 1NC/1NO	M20	SLM21-EPMT2
				2NC/1NO + 2NC	M20	SLM21-FPMT2
				2NC/1NO + 2NC/1NO	M20	SLM21-GPMT2
				3NC + 1NC/1NO	M20	SLM21-HPMT2
				3NC + 2NC	M20	SLM21-IPMT2
			3NC + 3NC	M20	SLM21-JPMT2	
			3NC + 2NC/1NO	M20	SLM21-KPMT2	
			2NC/1NO + 3NC	M20	SLM21-LPMT2	
			电磁锁定 机械释放	1NC/1NO + 1NC/1NO	M20	SLM21-APET2
				1NC/1NO + 2NC	M20	SLM21-BPET2
				2NC + 1NC/1NO	M20	SLM21-CPET2
				2NC + 2NC	M20	SLM21-DPET2
				2NC/1NO + 1NC/1NO	M20	SLM21-EPET2
				2NC/1NO + 2NC	M20	SLM21-FPET2
	2NC/1NO + 2NC/1NO	M20		SLM21-GPET2		
	3NC + 1NC/1NO	M20		SLM21-HPET2		
	3NC + 2NC	M20		SLM21-IPET2		
	3NC + 3NC	M20	SLM21-JPET2			
	3NC + 2NC/1NO	M20	SLM21-KPET2			
	2NC/1NO + 3NC	M20	SLM21-LPET2			
	金属	电磁铁 DC24V 绿色LED	机械锁定 电磁释放	1NC/1NO + 1NC/1NO	M20	SLM21-AMMT2
				1NC/1NO + 2NC	M20	SLM21-BMMT2
				2NC + 1NC/1NO	M20	SLM21-CMMT2
				2NC + 2NC	M20	SLM21-DMMT2
				2NC/1NO + 1NC/1NO	M20	SLM21-EMMT2
				2NC/1NO + 2NC	M20	SLM21-FMMT2
				2NC/1NO + 2NC/1NO	M20	SLM21-GMMT2
				3NC + 1NC/1NO	M20	SLM21-HMMT2
				3NC + 2NC	M20	SLM21-IMMT2
		3NC + 3NC	M20	SLM21-JMMT2		
		3NC + 2NC/1NO	M20	SLM21-KMMT2		
		2NC/1NO + 3NC	M20	SLM21-LMMT2		
电磁锁定 机械释放		1NC/1NO + 1NC/1NO	M20	SLM21-AMET2		
		1NC/1NO + 2NC	M20	SLM21-BMET2		
		2NC + 1NC/1NO	M20	SLM21-CMET2		
		2NC + 2NC	M20	SLM21-DMET2		
		2NC/1NO + 1NC/1NO	M20	SLM21-EMET2		
		2NC/1NO + 2NC	M20	SLM21-FMET2		
	2NC/1NO + 2NC/1NO	M20	SLM21-GMET2			
	3NC + 1NC/1NO	M20	SLM21-HMET2			
	3NC + 2NC	M20	SLM21-IMET2			
3NC + 3NC	M20	SLM21-JMET2				
3NC + 2NC/1NO	M20	SLM21-KMET2				
2NC/1NO + 3NC	M20	SLM21-LMET2				









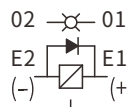
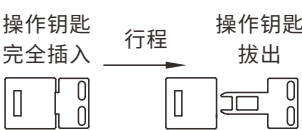

SLM21系列安全门锁

📄 SLM21系列选型表

释放钥匙位置	头部材质	电磁铁电压/指示灯	锁定/释放方式	触点类型 (门监控+ 锁定监控)	导管口尺寸	型号
前面解锁	塑料	电磁铁 DC24V 绿色LED	机械锁定 电磁释放	1NC/1NO + 1NC/1NO	M20	SLM21-APMF2
				1NC/1NO + 2NC	M20	SLM21-BPMF2
				2NC + 1NC/1NO	M20	SLM21-CPMF2
				2NC + 2NC	M20	SLM21-DPMF2
				2NC/1NO + 1NC/1NO	M20	SLM21-EPMF2
				2NC/1NO + 2NC	M20	SLM21-FPMF2
				2NC/1NO + 2NC/1NO	M20	SLM21-GPMF2
				3NC + 1NC/1NO	M20	SLM21-HPMF2
				3NC + 2NC	M20	SLM21-IPMF2
			3NC + 3NC	M20	SLM21-JPMF2	
			3NC + 2NC/1NO	M20	SLM21-KPMF2	
			2NC/1NO + 3NC	M20	SLM21-LPMF2	
			电磁锁定 机械释放	1NC/1NO + 1NC/1NO	M20	SLM21-APEF2
				1NC/1NO + 2NC	M20	SLM21-BPEF2
				2NC + 1NC/1NO	M20	SLM21-CPEF2
				2NC + 2NC	M20	SLM21-DPEF2
				2NC/1NO + 1NC/1NO	M20	SLM21-EPEF2
				2NC/1NO + 2NC	M20	SLM21-FPEF2
	2NC/1NO + 2NC/1NO	M20		SLM21-GPEF2		
	3NC + 1NC/1NO	M20		SLM21-HPEF2		
	3NC + 2NC	M20		SLM21-IPEF2		
	3NC + 3NC	M20	SLM21-JPEF2			
	3NC + 2NC/1NO	M20	SLM21-KPEF2			
	2NC/1NO + 3NC	M20	SLM21-LPEF2			
	金属	电磁铁 DC24V 绿色LED	机械锁定 电磁释放	1NC/1NO + 1NC/1NO	M20	SLM21-AMMF2
				1NC/1NO + 2NC	M20	SLM21-BMMF2
				2NC + 1NC/1NO	M20	SLM21-CMMF2
				2NC + 2NC	M20	SLM21-DMMF2
				2NC/1NO + 1NC/1NO	M20	SLM21-EMMF2
				2NC/1NO + 2NC	M20	SLM21-FMMF2
				2NC/1NO + 2NC/1NO	M20	SLM21-GMMF2
				3NC + 1NC/1NO	M20	SLM21-HMMF2
				3NC + 2NC	M20	SLM21-IMMF2
		3NC + 3NC	M20	SLM21-JMMF2		
		3NC + 2NC/1NO	M20	SLM21-KMMF2		
		2NC/1NO + 3NC	M20	SLM21-LMMF2		
电磁锁定 机械释放		1NC/1NO + 1NC/1NO	M20	SLM21-AMEF2		
		1NC/1NO + 2NC	M20	SLM21-BMEF2		
		2NC + 1NC/1NO	M20	SLM21-CMEF2		
		2NC + 2NC	M20	SLM21-DMEF2		
		2NC/1NO + 1NC/1NO	M20	SLM21-EMEF2		
		2NC/1NO + 2NC	M20	SLM21-FMEF2		
	2NC/1NO + 2NC/1NO	M20	SLM21-GMEF2			
	3NC + 1NC/1NO	M20	SLM21-HMEF2			
	3NC + 2NC	M20	SLM21-IMEF2			
3NC + 3NC	M20	SLM21-JMEF2				
3NC + 2NC/1NO	M20	SLM21-KMEF2				
2NC/1NO + 3NC	M20	SLM21-LMEF2				

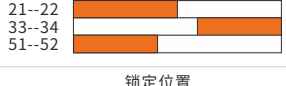
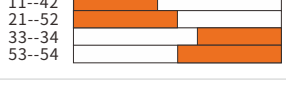
🔗 结点构成及动作

以下接线图为插入操作钥匙并处于锁键状态。(端子12和41、22和51/32和61为内部连接)

型号	触点类型 (门监控+锁定监控)	接线图		触点动作
		门监控	锁定监控	: 触点ON : 触点OFF
		 		
SLM21-AP□□□ SLM21-AM□□□	1NC/1NO + 1NC/1NO			
SLM21-BP□□□ SLM21-BM□□□	1NC/1NO + 2NC			
SLM21-CP□□□ SLM21-CM□□□	2NC + 1NC/1NO			
SLM21-DP□□□ SLM21-DM□□□	2NC + 2NC			
SLM21-EP□□□ SLM21-EM□□□	2NC/1NO + 1NC/1NO			
SLM21-FP□□□ SLM21-FM□□□	2NC/1NO + 2NC			
SLM21-GP□□□ SLM21-GM□□□	2NC/1NO + 2NC/1NO			
SLM21-HP□□□ SLM21-HM□□□	3NC + 1NC/1NO			
SLM21-IP□□□ SLM21-IM□□□	3NC + 2NC			
SLM21-JP□□□ SLM21-JM□□□	3NC + 3NC			
SLM21-KP□□□ SLM21-KM□□□	3NC + 2NC/1NO			
SLM21-LP□□□ SLM21-LM□□□	2NC/1NO + 3NC			

SLM21系列安全门锁

✂ 产品安装

- ★ 松开头部顶端的4个螺丝，旋转头部方向选择合适的操作钥匙孔位再进行安装。

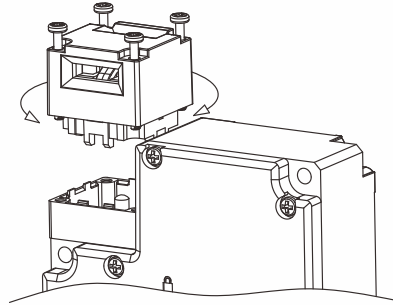

- ★ 安装在平开门时，需大于最小半径。

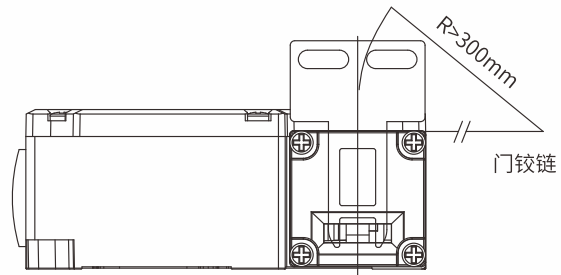

- ★ 请在准备位置范围(1~3.5mm)内安装开关和操作钥匙。

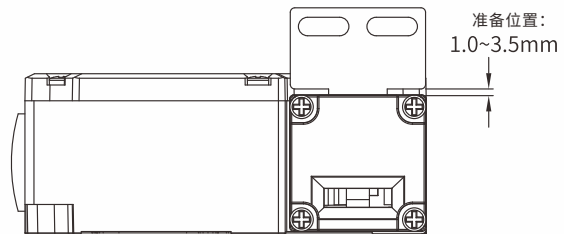

- ★ 操作钥匙的安装允许误差在操作钥匙插入孔中心为基准±1mm范围内。

